

LOGIC
GROUP

MATRIX 55

Type: ZDB5400

**Z-Wave Wall Switch with dimmer,
four pushbuttons and RGB indication**

Installation Guide and User's Manual





LOGIC
GROUP

Logic Group A/S

Theilgaards Allé 7

DK-4600 Køge

+45 7060 2080

info@logic-group.com

www.logic-group.com

Content

1	Safety Instructions	4
2	Disposal.....	4
3	Warranty	4
4	Product description.....	5
5	Installation guidelines	6
5.1.1	Fitting.....	6
5.1.2	Cable connecting/disconnecting	7
5.1.3	Demounting the pushbutton cover when the safety screw is mounted.....	7
5.1.4	Compatible design frames.....	7
5.2	Dimmer output.....	8
5.2.1	Trailing edge dimming.....	8
5.2.2	Leading edge dimming.....	8
5.3	Controllable light zones.....	9
5.4	Multi-way switching.....	10
5.5	LED control.....	12
5.6	Button - pairing	12
6	Behaviour within the Z-Wave network	13
6.1	Z-Wave network – add and remove.....	13
6.2	Security	14
6.3	Z-Wave Plus specific information.....	14
6.3.1	Z-Wave specific device information	14
6.3.2	Z-Wave specific endpoint information.....	15
7	Factory reset.....	17
8	Association groups	18
8.1	Association groups for the endpoints	18
8.2	Association groups for the root endpoint.....	20
9	Configuration parameters	21
10	Technical specifications	37

1 Safety Instructions

 Please read and follow the manual carefully.

- ! **Only authorised technicians under consideration of the country-specific installation norms may do works with 230 Volt mains power.**
- ! **Prior to the assembly of the product, the voltage network must be switched off.**

MATRIX is powered from the mains voltage (230V AC). In some countries the module is only allowed to be installed by authorized electricians. Mains voltage is very dangerous and can cause serious injury or death if mishandled. If the device is not correctly installed, the device can, in the worst case, pose a fire hazard.

2 Disposal



Dispose of the packaging in an environmentally-friendly manner. This product is labelled in accordance with European Directive 2012/19/EU concerning used electrical and electronic appliances (Waste Electrical and Electronic Equipment – WEEE). The guideline determines the framework for the return and recycling of used products as applicable throughout the EU.

3 Warranty

The guarantee conditions for this product are as defined by your representative in the country in which it is sold. Details regarding these conditions can be obtained from the dealer from whom the product was purchased. The bill of sale or receipt must be produced when making any claim under the terms of this guarantee.

4 Product description

MATRIX type ZDB5400 is a multifunction switch that can be mounted in a modular wall-box, with built-in light dimmer and four configurable pushbuttons with RGB indicators.

The pushbuttons can control other Z-Wave devices through the wireless Z-Wave network. The pushbuttons can send 'ON', 'OFF' and 'DIM' commands to the associated Z-Wave devices. These devices could be other light dimmers, blinds, sun-screens, etc.

The built-in light dimmer is per default attached to pushbutton 1. This attachment can be configured, thus it can be configured to not be controlled by any the four pushbuttons, so it can be independent of the local operation and thereby only be controllable from the Z-Wave network.

Furthermore, the pushbuttons can be configured to work together in pairs; thereby it can be possible to have one pushbutton to dim the light up, and another pushbutton to dim the light down.

MATRIX can also issue scene activation commands that can be used to activate scenes in the Z-Wave Controller.

The four RGB indicators, one for each pushbutton, can be used for different purposes, for example as orientation light, status light, different kind of indications, etc. The colour of the light and the control of it is fully controllable from the Z-Wave network.

MATRIX 55 also works as a repeater for the Z-Wave network and therefore expands the Z-Wave network coverage.

5 Installation guidelines

MATRIX 55 is designed for fitting into standard 60mm CE wall boxes. For compatible design frames, see section 5.1.4.

For easy installation MATRIX 55 is provided with a connection terminal with push-in terminations. The cable must have a stripped length between 9 and 10 mm. The maximum conductor size is 2.5 mm², or maximum 1.5 mm² for stranded conductors with a ferrule with plastic collar.

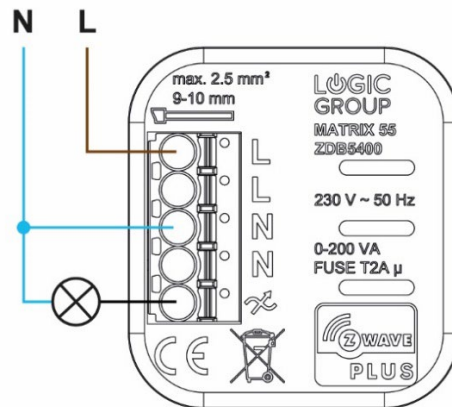

Figure 1: Wiring diagram

5.1.1 Fitting

Fit MATRIX using the elements in the figure below. The safety screw (4) is necessary in public buildings and businesses to avoid theft. Use bullets D) and F)-G) to mount the safety screw.

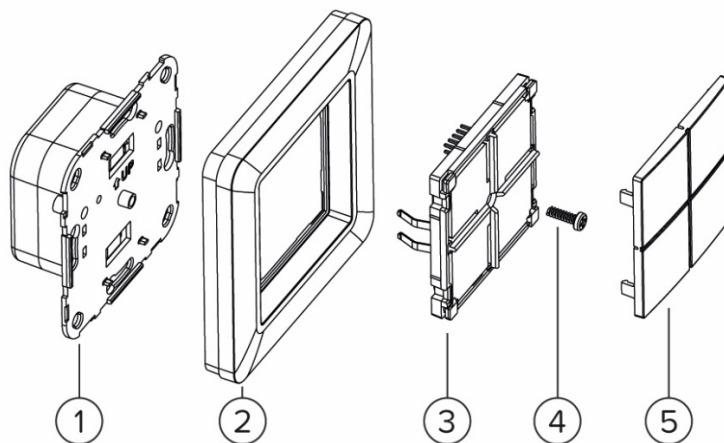

Figure 2: Fitting

- A) Mount the Insert (1) in the wall box using the wiring diagram above, regard the UP arrow.
- B) Add the insert to the Z-Wave system, see Chapter 6.
- C) Place the design frame (2) over the insert (1).
- D) (Optional) Remove Pushbutton cover (5) from the front module.
- E) Plug the Pushbutton base (3) into the Insert (1), regard the UP arrow.
- F) (Optional) Fasten the Pushbutton base to the Insert with the Safety screw (4).
- G) (Optional) Snap on the Pushbutton cover (5).

5.1.2 Cable connecting/disconnecting

When installing a MATRIX, simply push solid cables into the connection terminals. Stranded cables must be connected by use of the release-buttons. Activate the release-button on the terminal with a slotted screwdriver with a 2.5 mm slot while pushing in the cable

When removing the cables, use the release-buttons as described above.

5.1.3 Demounting the pushbutton cover when the safety screw is mounted

With the safety screw mounted, the pushbutton cover must be removed from the Pushbutton base before unscrewing. Use the following steps.

- 1) Loosen the cover with a slotted screwdriver in one side in the slot between the cover and the cover frame;
 - A) First insert the screwdriver in the right top just below the upper snap (a) and pop out the snap.
 - B) Afterwards insert the screwdriver in the right bottom just above the lower snap (b). Now release the entire right side.
- 2) Hold the right side out from the wall while the left side is released with a single pop somewhere on the left side (c).
- 3) Now it is possible to unscrew the safety screw and remove the front module and insert from the wall box.

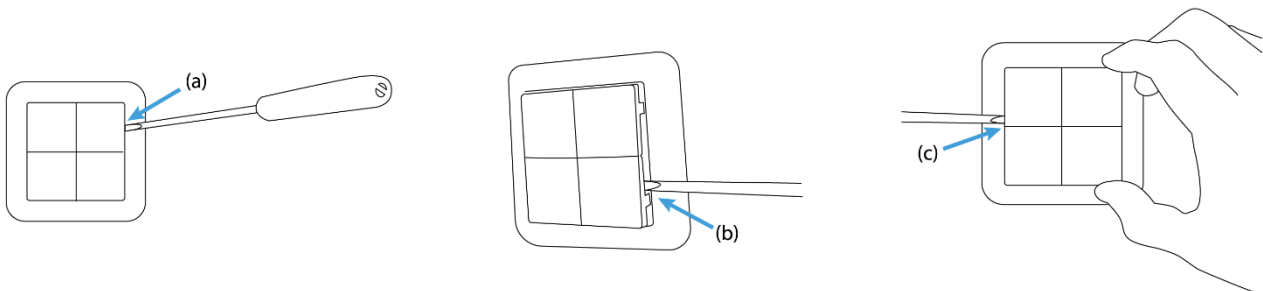

5.1.4 Compatible design frames

MATRIX 55 is compatible with a range of design frames from other manufacturers. The design frame must have a 55x55 mm opening and a depth of min. 10 mm. This includes, but is not limited to, the following frame systems:

- *Schneider Electric, Exxact*
- *Elko Plus*
- *GIRA, System 55*
- *Merten, System M*
- *Busch-Jaeger, Basic 55*

5.2 Dimmer output

5.2.1 Trailing edge dimming

Dimming by trailing edge is implemented by switching off the voltage in the sinus curve before time, and thereby limiting the power to the load.

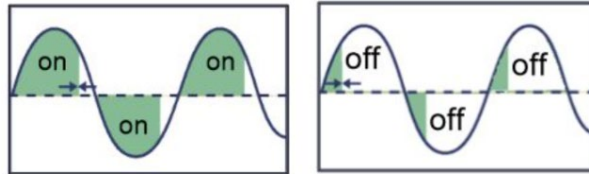

Figure 3: Trailing-edge dimming

Trailing-edge dimming is used for resistive loads (light bulbs, 230V halogen) and capacitive loads (electronic transformers e.g. 12V halogen “light” power supply, and LED retrofit).

This dimming solution is selected by setting configuration parameter #4 to the value ‘1’.

5.2.2 Leading edge dimming

Dimming by leading edge is working by delaying the switch-on of the voltage in the sinus curve, and thereby limiting the power to the load.

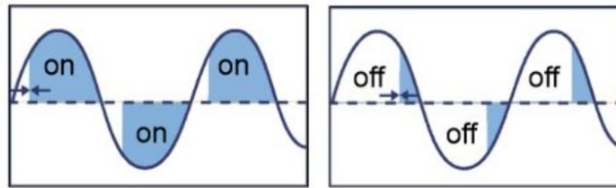

Figure 4: Leading-edge dimming

Leading edge can be used for resistive loads (light bulbs, 230V halogen) and inductive loads (iron core transformers for 12V halogen, “heavy” power supplies).

This dimming solution is selected by setting configuration parameter #4 to the value ‘2’.

WARNING. When using iron-core transformers, it is **IMPORTANT** to use leading edge dimming, otherwise it will damage the MATRIX module.

5.3 Controllable light zones

MATRIX can control up to four external light-zones and is able to control associated dimmers (Switch Multilevel) and on/off devices (Switch Binary). The built-in dimmer can be configured to belong to any of the four zones (configuration parameter #1), or it can be independent of the local operation and thereby only be controlled via Z-Wave commands.

The light-zones are controlled by the **Multichannel Endpoints** in the MATRIX module, where endpoint 1 – 4 corresponds to the zones 1 – 4. The root endpoint and endpoint 1 is the built-in dimmer device.

<i>Endpoint</i>	<i>Description</i>
1	Pushbutton 1, light-zone 1
2	Pushbutton 2, light-zone 2
3	Pushbutton 3, light-zone 3
4	Pushbutton 4, light-zone 4
5	Dimmer device.

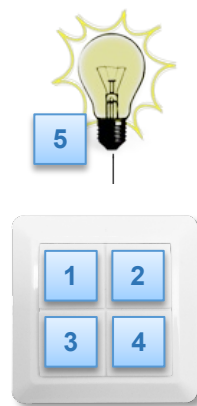

Figure 5: MATRIX 55 endpoints

Each pushbutton has a corresponding RGB LED indication, that can be configured to indicate the state of the corresponding light-zone. The indication can be configured to always turned off, briefly turned on at operation (default) or turned on or off to reflect the current status of the light-zone.

5.4 Multi-way switching

MATRIX can be used in a multi-way switching setup, where two or more devices are used to control the same light source. In this case, the device with the connected load is called the *master* device. The *master* device will then be reporting the current status to the *slave* devices that are part of the multi-way switching, and the *slave* devices will send control messages to the *master* device.

Example 1: two MATRIX devices.

In a system with MATRIX devices, where one of them has the load connected.

When the user turns on the light by using pushbutton 1 on the *master* device (#3), then the *master* device endpoint 5 (the dimmer endpoint) will send a **Basic Report** message to the *slave* device (#9) endpoint 2, so that the status for pushbutton 2 on the slave device will be updated with the actual level of the light. This will ensure that, when a user activates the pushbutton on the

slave device, it will send the correct command to the *master*.

When the *slave* device is controlling the light, by means of operation on pushbutton 2, then endpoint 2 on the *slave* device will send a **Multi-level Switch** command to the dimmer (endpoint 5) in the *master* device.

When the light regulation is finished, then again, the dimmer endpoint in the *master* device will send a **Basic Report** to endpoint 2 in the *slave* device.

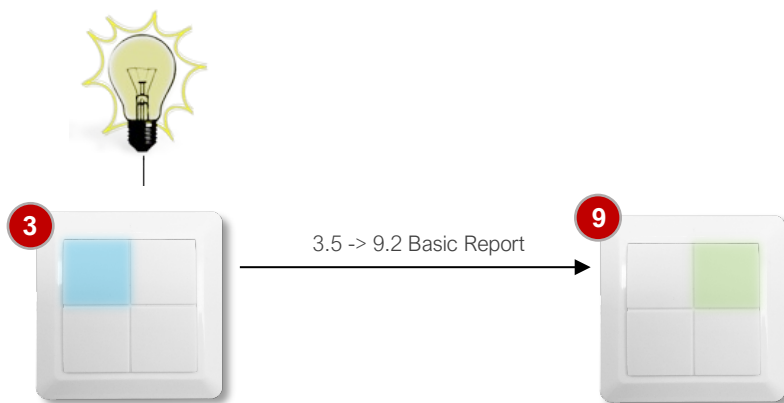

Figure 4. Multi-way switching between two MATRIX devices 1

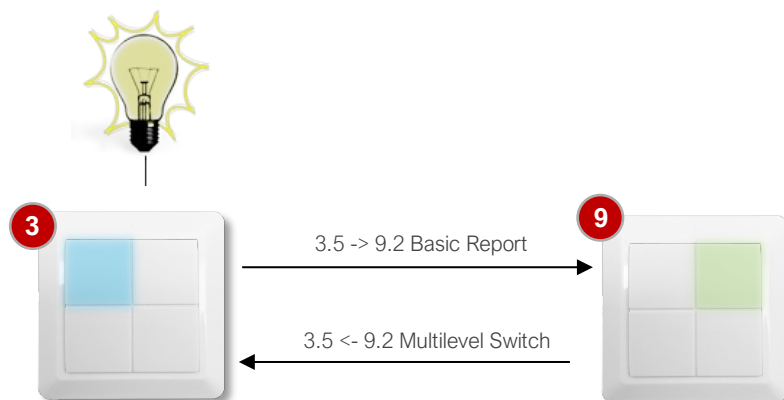

Figure 6: Multi-way switching between two MATRIX 55 devices 2

Example 2: two MATRIX devices and an external light dimmer.

This example illustrates a system with two MATRIX devices that will both control an external light dimmer. Synchronisation is needed between the status of the two involved pushbuttons, and when the light dimmer is controlled directly by the Z-Wave Controller.

In the figure the dimmer is controlled by endpoint 2 (pushbutton 2) in device #4 by sending

Multi-level Switch commands to the dimmer device #3.

When the dimmer is finished regulating the light to desired level, it will send **Basic Reports** to the two devices (to their endpoints) that are a part of the multi-way switching. Thereby, the two pushbuttons (endpoints) will get the current status of the dimmer and they can send the correct commands at the next operation of the pushbutton.

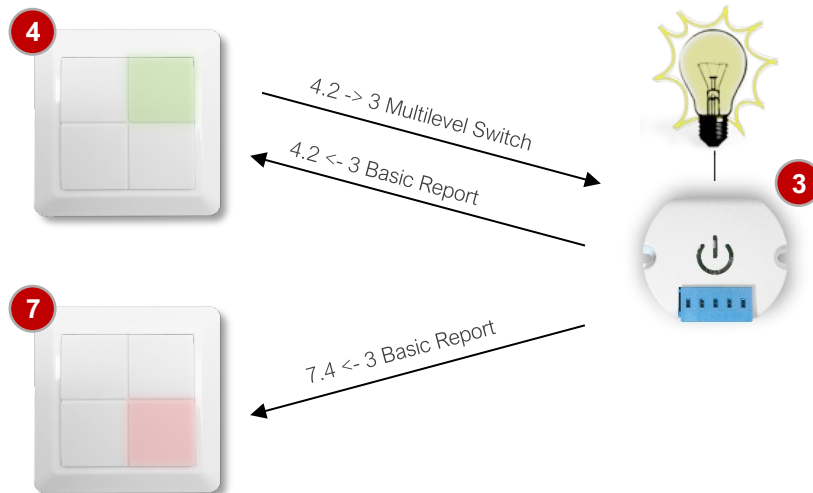

Figure 7: Multi-way switching with two MATRIX devices and a dimmer

5.5 LED control

Beneath the pushbutton cover in MATRIX are several LED's that can be used for different kind of status indications. The LED's is grouped into 4 squares that indicates status for each of the 4 pushbuttons. The LED's are RGB (Red, Green, Blue) LED's and it is therefore possible to mix these three base-colours into an almost unlimited number of colours.

In the default configuration MATRIX 55 indicates two status types with two different colour indications; Passive mode (no operation of the pushbutton) is indicated with 50% level of white light and Active mode (when the pushbutton is operated) is indicated with 5 seconds of blue light at 50% level.

It is possible to freely configure how the LED indications shall work and which status that shall be indicated. This is fulfilled by means of the different configuration parameters, individually for each group of LEDs.

With MATRIX 55 it is also possible to control the colour and light level of the four LED groups by sending the Z-Wave control command: **Command Class Switch Color Set** to the module.

This command makes it possible, individually for each pushbutton indicator, to set the value of the three base-colours (red, green, blue), and the command can be sent to each of the endpoints the represents the desired pushbutton indicator.

When a **Command Class Switch Color Set** – command is received, then the colour command will be used for setting the passive status of the pushbutton indicator. This behaviour can be changed by a configuration parameter for the pushbutton indicator:

- *Configuration parameter #21 for pushbutton 1*
- *Configuration parameter #29 for pushbutton 2*
- *Configuration parameter #37 for pushbutton 3*
- *Configuration parameter #45 for pushbutton 4*

5.6 Button - pairing

With MATRIX 55 it is possible to get two or more pushbuttons to work together; for example, if the user wants the upper left pushbutton to dim the light up and the lower left pushbutton to dim the light down, then this functionality is possible by means of setting the configuration parameters. It is possible to freely setup how the different pushbuttons shall work.



Figure 8: Button pairing example

If this pair-functionality is required to control the internal dimmer, then the pushbuttons that shall be used are selected by setting configuration parameter #1, where a bitmask decides which pushbuttons control the dimmer.

In the above example where pushbutton 1 and 3 control the dimmer, the configuration parameter #1 must be set to the value: $1 + 4 = 5$.

In this example, it is required that each pushbutton only sends one type of command when activated. This is configured by setting the following configuration parameters:

- *Configuration parameter #16 for pushbutton 1*
- *Configuration parameter #24 for pushbutton 2*
- *Configuration parameter #32 for pushbutton 3*
- *Configuration parameter #40 for pushbutton 4*

These parameters configure if the pushbutton shall switch on (dim up) or it shall switch off (dim down) when activated.

So, in the above example, where pushbutton 1 dims up and pushbutton 3 dims down, configuration parameter #16 is set to the value 4, and configuration parameter #32 is set to the value 3.

6 Behaviour within the Z-Wave network

This product can be operated in any Z-Wave network with other Z-Wave certified devices from other manufacturers. All non-battery-operated nodes within the network will act as repeaters regardless of vendor to increase reliability of the network.

On delivery, the device does not belong to any Z-Wave network. The device needs to be added to an existing wireless network to communicate with the devices of this network. Devices can also be removed from a network. Both add and remove process are initiated by the primary controller of the Z-Wave network. This controller will be turned into a mode for adding or removing devices. Please refer to your primary controller's manual on how to turn your controller into add or remove mode. Only if the primary controller is in add or remove mode, this device can be added or removed from the network. When the device is removed from the network, it will set the device back to factory default.

If the device already belongs to a network, follow the remove process before adding it in your network. Otherwise, the adding of this device will fail.

6.1 Z-Wave network – add and remove

MATRIX 55 is a SmartStart enabled product and can be added into a Z-Wave network by scanning the Z-Wave QR Code present on the product with a controller providing SmartStart inclusion. No further action is required and the SmartStart product will be added automatically within 10 minutes of being switched on in the network vicinity.

Find the DSK, QR code and PIN Code on the front of the insert module (Figure 9).

Add MATRIX 55 to a network with Classic Inclusion by pressing once on the switch (I) through the hole (Figure 10) with a non-conductive object.

Use same procedure for removing MATRIX 55 with Classic Exclusion.

If MATRIX 55 already belongs to a Z-Wave network, the remove process must be performed before adding it in a new network. Otherwise, the adding of the device will fail.

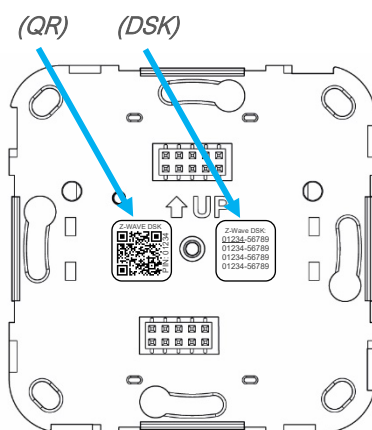

Figure 10: SmartStart Inclusion

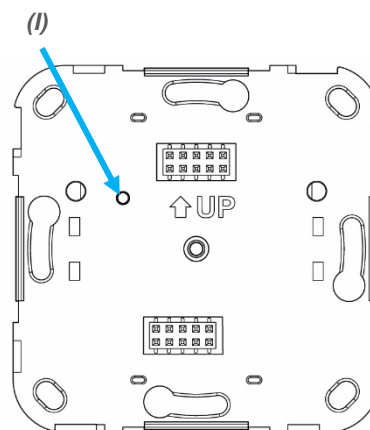

Figure 10: Classic Inclusion

6.2 Security

MATRIX 55 is a Security Enabled Z-Wave Plus product and a Security Enabled Z-Wave Controller must be used in order to fully utilize the security features of this product.

MATRIX 55 can operate in security S0 and S2 mode, this requires that the device is added in security mode during the inclusion process.

MATRIX 55 has a QR-code label that can be used when the module is added to the Z-Wave home network. The network controller will ask for a 5-digit code, which can be identified beneath the QR-code, and will then ask to confirm the rest of the code that is contained in this QR-code.

6.3 Z-Wave Plus specific information

MATRIX 55 is a Z-Wave Plus device and supports all required command classes for fulfilling the Z-Wave Plus specification. MATRIX 55 supports both Security S0 and Security S2.

6.3.1 Z-Wave specific device information

MATRIX reports following Z-Wave specific device information.

Property	Reported value
Device Type	Wall Controller
Basic Device Class	ROUTING_SLAVE
Generic Device Class	GENERIC_TYPE_WALL_CONTROLLER
Specific Device Class	SPECIFIC_TYPE_BASIC_WALL_CONTROLLER
Z-Wave Plus Node Type	NODE_TYPE_ZWAVEPLUS_NODE
Z-Wave Plus Role Type	ROLE_TYPE_SLAVE_ALWAYS_ON
Z-Wave Plus Icon Type	ICON_TYPE_GENERIC_WALL_CONTROLLER
Z-Wave Plus User Icon Type	ICON_TYPE_GENERIC_WALL_CONTROLLER

Manufacturer specific device information:

Property	Reported value
Manufacturer ID	0x0234
Product Type ID	0x0003
Product ID	0x0124

6.3.2 Z-Wave specific endpoint information.

Functionality specific for the root endpoint:

	Description
Supported Command Classes	Central Scene
Controlled Command Classes	Central Scene

Information and functionality for endpoint 1 - 4:

	Description
Device Type	Wall Controller
Generic Device Class	GENERIC_TYPE_WALL_CONTROLLER
Specific Device Class	SPECIFIC_TYPE_BASIC_WALL_CONTROLLER
Supported Command Classes	Basic, Switch Color, Switch Multilevel
Controlled Command Classes	Switch Binary, Switch Multilevel

Basic Set command mapping for endpoint 1 - 4:

When the endpoints receive Command Class Basic Set commands, then the command will switch the LED's in the related button on or off.

Information and functionality for endpoint 5:

	Description
Device Type	Switch Multilevel
Generic Device Class	GENERIC_TYPE_SWITCH_MULTILEVEL
Specific Device Class	SPECIFIC_TYPE_POWER_SWITCH_MULTILEVEL
Supported Command Classes	Basic, Switch Binary, Switch Multilevel
Controlled Command Classes	

Basic Set command mapping for endpoint 5:

When endpoint 5 receives a Command Class Basic Set command, then the command will be mapped as a Command Class Switch Multilevel Set command.

Supported command classes:

Supported Command Classes	Insecure Inclusion	Insecure on Secure Inclusion	Secure on Secure Inclusion
COMMAND_CLASS_ZWAVEPLUS_INFO (V2)	Yes	Yes	
COMMAND_CLASS_TRANSPORT_SERVICE (V2)	Yes	Yes	
COMMAND_CLASS_SECURITY	Yes	Yes	
COMMAND_CLASS_SECURITY_2	Yes	Yes	
COMMAND_CLASS_SUPERVISION (V1)	Yes	Yes	
COMMAND_CLASS_ASSOCIATION (V2)	Yes		Yes
COMMAND_CLASS_ASSOCIATION_GRP_INFO (V1)	Yes		Yes
COMMAND_CLASS_BASIC (V2)	Yes		Yes
COMMAND_CLASS_CENTRAL_SCENE (V3)	Yes		Yes
COMMAND_CLASS_CONFIGURATION (V3)	Yes		Yes
COMMAND_CLASS_DEVICE_RESET_LOCALLY (V1)	Yes		Yes
COMMAND_CLASS_FIRMWARE_UPDATE_MD (V4)	Yes		Yes
COMMAND_CLASS_MANUFACTURER_SPECIFIC (V2)	Yes		Yes
COMMAND_CLASS_MULTI_CHANNEL (V4)	Yes		Yes
COMMAND_CLASS_MULTI_CHANNEL_ASSOCIATION (V3)	Yes		Yes
COMMAND_CLASS_POWERLEVEL (V1)	Yes		Yes
COMMAND_CLASS_SWITCH_MULTILEVEL (V4)	Yes		Yes
COMMAND_CLASS_SWITCH_COLOR (V1)	Yes		Yes
COMMAND_CLASS_VERSION (V3)	Yes		Yes
Endpoint 1 – 4			
COMMAND_CLASS_ZWAVEPLUS_INFO (V2)	Yes	Yes	
COMMAND_CLASS_SUPERVISION (V1)	Yes	Yes	
COMMAND_CLASS_SECURITY	Yes	Yes	
COMMAND_CLASS_SECURITY_2	Yes	Yes	
COMMAND_CLASS_ASSOCIATION (V2)	Yes		Yes
COMMAND_CLASS_ASSOCIATION_GRP_INFO (V1)	Yes		Yes
COMMAND_CLASS_MULTI_CHANNEL_ASSOCIATION (V3)	Yes		Yes
COMMAND_CLASS_SWITCH_MULTILEVEL (V4)	Yes		Yes
COMMAND_CLASS_SWITCH_COLOR (V1)	Yes		Yes
Endpoint 5			
COMMAND_CLASS_ZWAVEPLUS_INFO (V2)	Yes	Yes	
COMMAND_CLASS_SUPERVISION (V1)	Yes	Yes	
COMMAND_CLASS_SECURITY	Yes	Yes	
COMMAND_CLASS_SECURITY_2	Yes	Yes	
COMMAND_CLASS_ASSOCIATION (V2)	Yes		Yes
COMMAND_CLASS_ASSOCIATION_GRP_INFO (V1)	Yes		Yes
COMMAND_CLASS_MULTI_CHANNEL_ASSOCIATION (V3)	Yes		Yes
COMMAND_CLASS_SWITCH_MULTILEVEL (V4)	Yes		Yes
COMMAND_CLASS_SWITCH_BINARY (V1)	Yes		Yes

7 Factory reset

NOTE: Only use this procedure when the primary network controller is missing or is otherwise inoperable.

MATRIX 55 can be factory reset by holding the switch through the hole (I) for at least 10 seconds.

By following this procedure, all configuration parameters and the device network address will be reset back to the values they had when the device was manufactured.

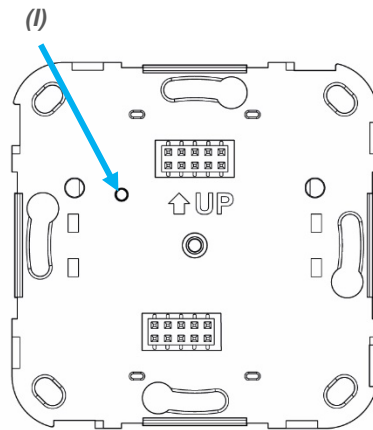

8 Association groups

From a Z-Wave controller's point of view, MATRIX 55 will consist of a root device and five endpoint devices – if the controller is supporting multi-channel devices, otherwise is only the root device seen by the controller.

The five endpoints consist of a dimmer – endpoint to control the built-in dimmer output, and four endpoints that represents the four pushbuttons with LED indications.

8.1 Association groups for the endpoints

Below is an overview of the different association groups for each the endpoints.

In the group column indicates the first number, the group number for the current endpoint and the next number is the group number for the root endpoint.

Root endpoint

Group 1 / 1 *Lifeline.*
Sends Device Reset notifications, and **Central Scene** notifications.
Max. nodes in the group: 5

Endpoint 1

Pushbutton 1

Group 1 / - *Lifeline. (Shared group with the root endpoint)*
Sends **Multilevel Report** with the actual level of LED's in pushbutton 1.
This can be used by the network controller to update its user interface.
Max. nodes in the group: 0

Group 2 / 2 Nodes in this group also receive **Basic Report** with the actual state of pushbutton 1. It can be used by other MATRIX devices to update their internal pushbutton states. Normally the state is reported by the controlled device, but in cases where this is not possible, the MATRIX devices can get synchronised by reporting to each other.
Max. nodes in the group: 5

Group 3 / 3 Nodes in this group receive **Switch Binary Set** commands when pushbutton 1 is operated. It can be used for controlling other Z-Wave devices, e.g. a relay module.
Max. nodes in the group: 5

Group 4 / 4 Nodes in this group receive **Switch Multilevel Set / Switch Multilevel Start Level Change / Switch Multilevel Stop Level Change** when pushbutton 1 is operated. It can, as an example, be used for controlling light dimmers.
Max. nodes in the group: 5

Endpoint 2

Pushbutton 2

Group 1 / - *Lifeline. (Shared group with the root endpoint)*
Sends **Multilevel Report** with the actual level of LED's in pushbutton 2.
This can be used by the network controller to update its user interface.
Max. nodes in the group: 0

- Group 2 / 5 Nodes in this group also receives **Basic Report** with the actual state of pushbutton 2. It can be used by other MATRIX devices to update their internal pushbutton states. Normally the state is reported by the controlled device, but in cases where this is not possible, the MATRIX devices can get synchronised by reporting to each other.
Max. nodes in the group: 5
- Group 3 / 6 Nodes in this group receives **Switch Binary Set** commands when pushbutton 2 is operated. It can be used for controlling other Z-Wave devices, e.g. a relay module.
Max. nodes in the group: 5
- Group 4 / 7 Nodes in this group receives **Switch Multilevel Set / Switch Multilevel Start Level Change / Switch Multilevel Stop Level Change** when pushbutton 2 is operated. It can, as an example, be used for controlling light dimmers.
Max. nodes in the group: 5

Endpoint 3**Pushbutton 3**

- Group 1 / - *Lifeline. (Shared group with the root endpoint)*
Sends **Multilevel Report** with the actual level of LED's in pushbutton 3.
This can be used by the network controller to update its user interface.
Max. nodes in the group: 0
- Group 2 / 8 Nodes in this group also receives **Basic Report** with the actual state of pushbutton 3. It can be used by other MATRIX devices to update their internal pushbutton states. Normally the state is reported by the controlled device, but in cases where this is not possible, the MATRIX devices can get synchronised by reporting to each other.
Max. nodes in the group: 5
- Group 3 / 9 Nodes in this group receives **Switch Binary Set** commands when pushbutton 3 is operated. It can be used for controlling other Z-Wave devices, e.g. a relay module.
Max. nodes in the group: 5
- Group 4 / 10 Nodes in this group receives **Switch Multilevel Set / Switch Multilevel Start Level Change / Switch Multilevel Stop Level Change** when pushbutton 3 is operated. It can, as an example, be used for controlling light dimmers.
Max. nodes in the group: 5

Endpoint 4**Pushbutton 4**

- Group 1 / - *Lifeline. (Shared group with the root endpoint)*
Sends **Multilevel Report** with the actual level of LED's in pushbutton 4.
This can be used by the network controller to update its user interface.
Max. nodes in the group: 5
- Group 2 / 11 Nodes in this group also receives **Basic Report** with the actual state of pushbutton 4. It can be used by other MATRIX devices to update their internal pushbutton states. Normally the state is reported by the controlled device, but in cases where this is not possible, the MATRIX devices can get synchronised by reporting to each other.
Max. nodes in the group: 5

Group 3 / 12 Nodes in this group receives **Switch Binary Set** commands when pushbutton 4 is operated. It can be used for controlling other Z-Wave devices, e.g. a relay module.

Max. nodes in the group: 5

Group 4 / 13 Nodes in this group receives **Switch Multilevel Set / Switch Multilevel Start Level Change / Switch Multilevel Stop Level Change** when pushbutton 4 is operated. It can, as an example, be used for controlling light dimmers.

Max. nodes in the group: 5

Endpoint 5 **Dimmer device**

Group 1 / - *Lifeline. (Shared group with the root endpoint)*

Sends **Switch Multilevel Report**, that the network controller can use for maintaining its user interface.

Max. nodes in the group: 0

Group 2 / 14 Sends **Basic Report** with information about the actual level for the dimmer. This report is used by other MATRIX devices that are used for controlling this dimmer.

Max. nodes in the group: 5

8.2 Association groups for the root endpoint

This table shows the relationship between the association groups for the root endpoint and the sub-endpoints.

<i>Root endpoint association group</i>	<i>Endpoint</i>	<i>Endpoint association group</i>	<i>Description</i>
2	1	2	Basic Report
3	1	3	Binary Switch Set
4	1	4	Multi-Level Switch
5	2	2	Basic Report
6	2	3	Binary Switch Set
7	2	4	Multi-Level Switch
8	3	2	Basic Report
9	3	3	Binary Switch Set
10	3	4	Multi-Level Switch
11	4	2	Basic Report
12	4	3	Binary Switch Set
13	4	4	Multi-Level Switch
14	5	2	Basic Report

9 Configuration parameters

Z-Wave products are supposed to work out of the box after they are added to the Z-Wave network, however certain configurations of a device can alter the functionality to better serve the user's needs or unlock further enhanced features.

Parameter 1, Parameter size 1 byte. Operating pushbutton(s) for dimmer.

This parameter specifies which pushbutton(s) that shall be used to control the built-in dimmer.

The parameter is a bitmask, so each of the values can be added up in order to have several pushbuttons to operate the dimmer.

<i>Value</i>	<i>Description</i>
0	No local operation of the dimmer.
1	Pushbutton 1 controls the dimmer. (Default)
2	Pushbutton 2 controls the dimmer.
4	Pushbutton 3 controls the dimmer.
8	Pushbutton 4 controls the dimmer.

Parameter 2, Parameter size 1 byte. Duration of dimming.

This parameter specifies the duration of a full regulation of the light from 0% to 100%. A regulation of the light with 1% will take 1/100 of the specified duration. This is used when a pushbutton is held-down for controlling the dimming, and when the dimming is fulfilled from other Z-Wave devices when specifying factory default duration.

<i>Value</i>	<i>Description</i>
0	Immediately.
1 - 127	Duration in seconds. (Default is 5 seconds).
128 - 255	Duration in minutes (minus 127) from 1 – 128 minutes, where 128 is 1 minute.

Parameter 3, Parameter size 1 byte. Duration of on/off.

This parameter specifies the duration when turning the light on or off.

<i>Value</i>	<i>Description</i>
0	Immediately. (Default).
1 - 127	Time in seconds.
128 - 255	Time in minutes (minus 127) from 1 – 128 minutes, where 128 is 1 minute.

Parameter 4, Parameter size 1 byte. Dimmer mode.

The dimmer can work in three different modes: on/off, leading edge or trailing edge.

<i>Value</i>	<i>Description</i>
0	No dimming, only on/off (0%/100%).
1	Trailing edge dimming. (Default)
2	Leading edge dimming.

Parameter 5, Parameter size 1 byte. Dimmer minimum level.

This parameter specifies the actual level of the dimmer output when set to 0%.

<i>Value</i>	<i>Description</i>
0 - 99	Corresponds to 0 – 99% (Default is 0)

Parameter 6, Parameter size 1 byte. Dimmer maximum level.

This parameter specifies the actual level of the dimmer output when set to 99%.

<i>Value</i>	<i>Description</i>
1 - 99	Corresponds to 1 – 99% (Default is 99)

Parameter 7, Parameter size 1 byte. Central Scene notifications.

This parameter can be used for disabling Central Scene notifications.

<i>Value</i>	<i>Description</i>
0	Notifications are disabled.
1	Notifications are enabled. (Default)

Parameter 8, Parameter size 1 byte. Double-activation functionality.

This parameter specifies the reaction when double-activating the pushbuttons.

<i>Value</i>	<i>Description</i>
0	Double-activation disabled.
1	Double-activation sets light to 100%. (Default)

Parameter 9, Parameter size 1 byte. Not used.

<i>Value</i>	<i>Description</i>
0	

Parameter 10, Parameter size 1 byte. Enhanced LED control.

This parameter can be used for enabling the enhanced LED control. See document about MATRIX enhanced LED control.

<i>Value</i>	<i>Description</i>
0	Enhanced LED control is disabled. (Default)
1	Enhanced LED control is enabled.

Parameter 11, Parameter size 1 byte. Pushbutton debounce timer.

Pushbutton input debounce time in 0.01 seconds resolution.

<i>Value</i>	<i>Description</i>
1 - 255	1 – 2.55 seconds. Default is 5, which equals to a debounce-filter on 50 milliseconds (0.05 seconds).

Parameter 12, Parameter size 1 byte. Pushbutton press threshold time.

Specifies the time that a pushbutton must be activated before it is detected as pressed. Resolution is in 0.01 seconds.

<i>Value</i>	<i>Description</i>
1 - 255	1 – 2.55 seconds. Default is 20, which equals to 200 milliseconds (0.2 seconds).

Parameter 13, Parameter size 1 byte. Pushbutton held threshold time.

Specifies the time that a pushbutton must have been activated before it is accepted as “held-down”. Resolution is 0.01 seconds.

<i>Value</i>	<i>Description</i>
1 - 255	1 – 2.55 seconds. Default is 50, which equals to 500 milliseconds (0,5 seconds).

Parameter 14, Parameter size 4 bytes. Global brightness control.

This parameter specifies a common brightness for each of the three base colours for all four pushbutton indicators.

<i>Value</i>	<i>Description</i>
Byte 1: Red brightness	
0 - 255	Brightness level for the red colour in the 4 indicator groups. (Default is 255)
Byte 2: Green brightness	
0 - 255	Brightness level for the green colour in the 4 indicator groups. (Default is 255)
Byte 3: Blue brightness	
0 - 255	Brightness level for the blue colour in the 4 indicator groups. (Default is 255)
Byte 4: Not used – must be set to 0.	

Parameter 15, Parameter size 2 bytes. Associations groups, transmission when included secure.

This parameter specifies if commands are transmitted as a secure message for each of the association groups.

This parameter is only used when the device is included in security mode (either S0 or S2).

<i>Value</i>	<i>Description</i>
0	All messages in all groups are sent as insecure.
1	Messages in association group 2 are sent as secure.
2	Messages in association group 3 are sent as secure.
4	Messages in association group 4 are sent as secure.
8	Messages in association group 5 are sent as secure.
16	Messages in association group 6 are sent as secure.
32	Messages in association group 7 are sent as secure.
64	Messages in association group 8 are sent as secure.
128	Messages in association group 9 are sent as secure.
256	Messages in association group 10 are sent as secure.
512	Messages in association group 11 are sent as secure.
1024	Messages in association group 12 are sent as secure.
2048	Messages in association group 13 are sent as secure.
4096	Messages in association group 14 are sent as secure.
8191	Messages in all association groups are sent as secure. (Default)

NB. *The above values are bitmasks and can be added up to select several options.*

Parameter 16, Parameter size 1 byte. Pushbutton 1 functionality.

This parameter specifies the functionality of pushbutton 1.

<i>Value</i>	<i>Description</i>
0	Standard toggle-function, the state is switched between on and off, dimming up and down. (Default)
1	Automatic turn off after the time has expired (staircase lighting function), the time is specified in the next configuration parameter.
2	Automatic turn on after the time has expired, the time is specified in the next configuration parameter.
3	Always turn off or dim down. Using this parameter, the pushbutton can only send 'off' or 'dim down' commands. Use this in pair with another pushbutton with value 4 (see chapter 5.6).
4	Always turn on or dim up. Using this parameter, the pushbutton can only send 'on' or 'dim up' commands. Use this in pair with another pushbutton with value 3 (see chapter 5.6).

Parameter 17, Parameter size 2 bytes. Timer value for pushbutton 1.

This parameter specifies the time used in previous configuration parameter. This parameter is only applicable if previous parameter has value 1 or 2.

<i>Value</i>	<i>Description</i>
0 – 43200	Specifies the time in seconds. Default is 300 = 5 minutes.

Parameter 18, Parameter size 4. **Multi-Level Switch Set** values for pushbutton 1.

<i>Value</i>	<i>Description</i>
Byte 1: Enable / Disable	
0	Disabled – A single activation of the pushbutton will not send commands to devices in association group 4.
1	Enabled – A single activation will send commands to devices in association group 4. Devices will receive commands with the values set in Byte 2 and 3 (Default).
Byte 2: Upper switch value	
0 – 99, 255	When single pressing the pushbutton for ON, a Multilevel Switch Set with this value will be send to devices in association group 4. (Default = 255)
Byte 3: Lower switch value	
0 - 99	When single pressing the pushbutton for OFF, a Multilevel Switch Set with this value will be send to devices in association group 4. (Default = 0)
Byte 4: Not used – must be set to 0.	

Parameter 19, Parameter size 1 byte. **Basic Set** support for pushbutton 1.

This parameter specifies how received **Basic Set** commands are handled.

<i>Value</i>	<i>Description</i>
0	Basic Set only controls the pushbutton indicator LEDs, ON/OFF. (Default)
1	Basic Set controls the internal switch status and the pushbutton indicator LEDs.
2	Basic Set is handled as if the user had activated the pushbutton, including transmission of commands via the association groups.

Parameter 20, Parameter size 1 byte. Pushbutton 1 LED indication.

This parameter specifies how the LED indication is controlled.

<i>Value</i>	<i>Description</i>
0	Internal LED control is disabled, only external commands control the indication.
1	The LED indication follows the switch status.
2	The LED indication follows the switch status – with inverted functionality.
3	Same as 1
4	Same as 2
5	The LED indication follows the status of the internal dimmer, ON or OFF.
6	The LED indication follows the status of the internal dimmer with inverted functionality, ON or OFF.
7	The LED indicator is ON for 5 seconds when the pushbutton is activated. (Default).

Parameter 21, Parameter size 1 byte. Colour commands for pushbutton 1 LED indication.

This parameter specifies how **Command Class Switch Color** commands are handled.

<i>Value</i>	<i>Description</i>
0	Direct control; the LED indication shows the received colour immediately, until the pushbutton is activated.
1	Colour command sets the colour for OFF indication. (Default).
2	Colour command sets the colour for ON indication.

Parameter 22, Parameter size 4 bytes. ON indication RGB-saturation for pushbutton 1.

This parameter specifies the saturation levels for the red, green and blue LEDs, when ON status is indicated. (Default is the ON-state indicated by a 50% blue colour).

<i>Value</i>	<i>Description</i>
Byte 1: Colour saturation, red.	
0 - 255	Specifies the saturation for the red LEDs. (Default is 0)
Byte 2: Colour saturation, green.	
0 - 255	Specifies the saturation for the green LEDs. (Default is 0)
Byte 3: Colour saturation, blue.	
0 - 255	Specifies the saturation for the blue LEDs. (Default is 127)
Byte 4: LED control.	
0 - 255	LED indicator control; see the application note about this parameter. (Default is 0)

Parameter 23, Parameter size 4 bytes. OFF indication RGB-saturation for pushbutton 1.

This parameter specifies the saturation levels for the red, green and blue LEDs, when OFF status is indicated. (Default is the OFF-state indicated as a low white light on 5%).

<i>Value</i>	<i>Description</i>
Byte 1: Colour saturation, red.	
0 - 255	Specifies the saturation for the red LEDs. (Default is 47).
Byte 2: Colour saturation, green.	
0 - 255	Specifies the saturation for the green LEDs. (Default is 47)
Byte 3: Colour saturation, blue.	
0 - 255	Specifies the saturation for the blue LEDs. (Default is 47)
Byte 4: LED control.	
0 - 255	LED indicator control; see the application note about this parameter. (Default is 0)

Parameter 24, Parameter size 1 byte. Pushbutton 2 functionality.

This parameter specifies the functionality of pushbutton 2.

<i>Value</i>	<i>Description</i>
0	Standard toggle-function, the state is switched between on and off, dimming up and down. (Default)
1	Automatic turn off after the time has expired (staircase lighting function), the time is specified in the next configuration parameter.
2	Automatic turn on after the time has expired, the time is specified in the next configuration parameter.
3	Always turn off or dim down. Using this parameter, the pushbutton can only send 'off' or 'dim down' commands. Use this in pair with another pushbutton with value 4 (see chapter 5.6)
4	Always turn on or dim up. Using this parameter, the pushbutton can only send 'on' or 'dim up' commands. Use this in pair with another pushbutton with value 3 (see chapter 5.6)

Parameter 25, Parameter size 2 bytes. Timer value for pushbutton 2.

This parameter specifies the time used by the previous configuration parameter.

<i>Value</i>	<i>Description</i>
0 – 43200	Specifies the time in seconds. Default is 300 = 5 minutes.

Parameter 26, Parameter size 4. **Multi-Level Switch Set** values for pushbutton 2.

<i>Value</i>	<i>Description</i>
Byte 1: Enable / Disable	
0	Disabled – A single activation of the pushbutton will not send commands to devices in association group 4.
1	Enabled – A single activation will send commands to devices in association group 4. Devices will receive commands with the values set in Byte 2 and 3 (Default).
Byte 2: Upper switch value	
0 – 99, 255	When single pressing the pushbutton for ON, a Multilevel Switch Set with this value will be send to devices in association group 4. (Default = 255)
Byte 3: Lower switch value	
0 - 99	When single pressing the pushbutton for OFF, a Multilevel Switch Set with this value will be send to devices in association group 4. (Default = 0)
Byte 4: Not used – must be set to 0.	

Parameter 27, Parameter size 1 byte. Basic Set support for pushbutton 2.

This parameter specifies how received **Basic Set** commands are handled.

<i>Value</i>	<i>Description</i>
0	Basic Set only controls the pushbutton indicator LEDs, ON/OFF. (Default)
1	Basic Set controls the internal switch status and the pushbutton indicator LEDs.
2	Basic Set is handled as if the user had activated the pushbutton, including transmission of commands via the association groups.

Parameter 28, Parameter size 1 byte. Pushbutton 2 LED indication.

This parameter specifies how the LED indication is controlled.

<i>Value</i>	<i>Description</i>
0	Internal LED control is disabled, only external commands control the indication.
1	The LED indication follows the switch status.
2	The LED indication follows the switch status – with inverted functionality.
3	Same as 1
4	Same as 2
5	The LED indication follows the status of the internal dimmer, ON or OFF.
6	The LED indication follows the status of the internal dimmer with inverted functionality, ON or OFF.
7	The LED indicator is ON for 5 seconds when the pushbutton is activated. (Default).

Parameter 29, Parameter size 1 byte. Colour commands for pushbutton 2 LED indication.

This parameter specifies how **Command Class Switch Color** commands is handled.

<i>Value</i>	<i>Description</i>
0	Direct control; the LED indication shows the received colour immediately, until the pushbutton is activated.
1	Colour command sets the colour for OFF indication. (Default).
2	Colour command sets the colour for ON indication.

Parameter 30, Parameter size 4 bytes. ON indication RGB-saturation for pushbutton 2.

This parameter specifies the saturation levels for the red, green and blue LEDs, when ON status is indicated. (Default is the ON-state indicated by a 50% blue colour).

<i>Value</i>	<i>Description</i>
Byte 1: Colour saturation, red.	
0 - 255	Specifies the saturation for the red LEDs. (Default is 0)
Byte 2: Colour saturation, green.	
0 - 255	Specifies the saturation for the green LEDs. (Default is 0)
Byte 3: Colour saturation, blue.	
0 - 255	Specifies the saturation for the blue LEDs. (Default is 127)
Byte 4: LED control.	
0 - 255	LED indicator control; see the application note about this parameter. (Default is 0)

Parameter 31, Parameter size 4 bytes. OFF indication RGB-saturation for pushbutton 2.

This parameter specifies the saturation levels for the red, green and blue LEDs, when OFF status is indicated. (Default is the OFF-state indicated as a low white light on 5%).

<i>Value</i>	<i>Description</i>
Byte 1: Colour saturation, red.	
0 - 255	Specifies the saturation for the red LEDs. (Default is 47).
Byte 2: Colour saturation, green.	
0 - 255	Specifies the saturation for the green LEDs. (Default is 47)
Byte 3: Colour saturation, blue.	
0 - 255	Specifies the saturation for the blue LEDs. (Default is 47)
Byte 4: LED control.	
0 - 255	LED indicator control; see the application note about this parameter. (Default is 0)

Parameter 32, Parameter size 1 byte. Pushbutton 3 functionality.

This parameter specifies the functionality of pushbutton 3.

<i>Value</i>	<i>Description</i>
0	Standard toggle-function, the state is switched between on and off, dimming up and down. (Default)
1	Automatic turn off after the time has expired (staircase lighting function), the time is specified in the next configuration parameter.
2	Automatic turn on after the time has expired, the time is specified in the next configuration parameter.
3	Always turn off or dim down. Using this parameter, the pushbutton can only send 'off' or 'dim down' commands. Use this in pair with another pushbutton with value 4 (see chapter 5.6).
4	Always turn on or dim up. Using this parameter, the pushbutton can only send 'on' or 'dim up' commands. Use this in pair with another pushbutton with value 3 (see chapter 5.6).

Parameter 33, Parameter size 2 bytes. Timer value for pushbutton 3.

This parameter specifies the time used by the previous configuration parameter.

<i>Value</i>	<i>Description</i>
0 – 43200	Specifies the time in seconds. Default is 300 = 5 minutes.

Parameter 34, Parameter size 4. **Multi-Level Switch Set** values for pushbutton 3.

<i>Value</i>	<i>Description</i>
Byte 1: Enable / Disable	
0	Disabled – A single activation of the pushbutton will not send commands to devices in association group 4.
1	Enabled – A single activation will send commands to devices in association group 4. Devices will receive commands with the values set in Byte 2 and 3 (Default).
Byte 2: Upper switch value	
0 – 99, 255	When single pressing the pushbutton for ON, a Multilevel Switch Set with this value will be send to devices in association group 4. (Default = 255)
Byte 3: Lower switch value	
0 - 99	When single pressing the pushbutton for OFF, a Multilevel Switch Set with this value will be send to devices in association group 4. (Default = 0)
Byte 4: Not used – must be set to 0.	

Parameter 35, Parameter size 1 byte. Basic Set support for pushbutton 3.

This parameter specifies how received **Basic Set** commands are handled.

<i>Value</i>	<i>Description</i>
0	Basic Set only controls the pushbutton indicator LEDs, ON/OFF. (Default)
1	Basic Set controls the internal switch status and the pushbutton indicator LEDs.
2	Basic Set is handled as if the user had activated the pushbutton, including transmission of commands via the association groups.

Parameter 36, Parameter size 1 byte. Pushbutton 3 LED indication.

This parameter specifies how the LED indication is controlled.

<i>Value</i>	<i>Description</i>
0	Internal LED control is disabled, only external commands control the indication.
1	The LED indication follows the switch status.
2	The LED indication follows the switch status – with inverted functionality.
3	Same as 1
4	Same as 2
5	The LED indication follows the status of the internal dimmer, ON or OFF.
6	The LED indication follows the status of the internal dimmer with inverted functionality, ON or OFF.
7	The LED indicator is ON for 5 seconds when the pushbutton is activated. (Default).

Parameter 37, Parameter size 1 byte. Colour commands for pushbutton 3 LED indication.

This parameter specifies how **Command Class Switch Color** commands are handled.

<i>Value</i>	<i>Description</i>
0	Direct control; the LED indication shows the received colour immediately, until the pushbutton is activated.
1	Colour command sets the colour for OFF indication. (Default).
2	Colour command sets the colour for ON indication.

Parameter 38, Parameter size 4 bytes. ON indication RGB-saturation for pushbutton 3.

This parameter specifies the saturation levels for the red, green and blue LEDs, when ON status is indicated. (Default is the ON-state indicated by a 50% blue colour).

<i>Value</i>	<i>Description</i>
Byte 1: Colour saturation, red.	
0 - 255	Specifies the saturation for the red LEDs. (Default is 0)
Byte 2: Colour saturation, green.	
0 - 255	Specifies the saturation for the green LEDs. (Default is 0)
Byte 3: Colour saturation, blue.	
0 - 255	Specifies the saturation for the blue LEDs. (Default is 127)
Byte 4: LED control.	
0 - 255	LED indicator control; see the application note about this parameter. (Default is 0)

Parameter 39, Parameter size 4 bytes. OFF indication RGB-saturation for pushbutton 3.

This parameter specifies the saturation levels for the red, green and blue LEDs, when OFF status is indicated. (Default is the OFF-state indicated as a low white light on 5%).

<i>Value</i>	<i>Description</i>
Byte 1: Colour saturation, red.	
0 - 255	Specifies the saturation for the red LEDs. (Default is 47).
Byte 2: Colour saturation, green.	
0 - 255	Specifies the saturation for the green LEDs. (Default is 47)
Byte 3: Colour saturation, blue.	
0 - 255	Specifies the saturation for the blue LEDs. (Default is 47)
Byte 4: LED control.	
0 - 255	LED indicator control; see the application note about this parameter. (Default is 0)

Parameter 40, Parameter size 1 byte. Pushbutton 4 functionality.

This parameter specifies the functionality of pushbutton 4.

<i>Value</i>	<i>Description</i>
0	Standard toggle-function, the state is switched between on and off, dimming up and down. (Default)
1	Automatic turn off after the time has expired (staircase lighting function), the time is specified in the next configuration parameter.
2	Automatic turn on after the time has expired, the time is specified in the next configuration parameter.
3	Always turn off or dim down. Using this parameter, the pushbutton can only send 'off' or 'dim down' commands. Use this in pair with another pushbutton with value 4 (see chapter 5.6).
4	Always turn on or dim up. Using this parameter, the pushbutton can only send 'on' or 'dim up' commands. Use this in pair with another pushbutton with value 3 (see chapter 5.6l).

Parameter 41, Parameter size 2 bytes. Timer value for pushbutton 4.

This parameter specifies the time used by the previous configuration parameter.

<i>Value</i>	<i>Description</i>
0 – 43200	Specifies the time in seconds. Default is 300 = 5 minutes.

Parameter 42, Parameter size 4. Multi-Level Switch Set values for pushbutton 4.

<i>Value</i>	<i>Description</i>
Byte 1: Enable / Disable	
0	Disabled – A single activation of the pushbutton will not send commands to devices in association group 4.
1	Enabled – A single activation will send commands to devices in association group 4. Devices will receive commands with the values set in Byte 2 and 3 (Default).
Byte 2: Upper switch value	
0 – 99, 255	When single pressing the pushbutton for ON, a Multilevel Switch Set with this value will be send to devices in association group 4. (Default = 255)
Byte 3: Lower switch value	
0 - 99	When single pressing the pushbutton for OFF, a Multilevel Switch Set with this value will be send to devices in association group 4. (Default = 0)
Byte 4: Not used – must be set to 0.	

Parameter 43, Parameter size 1 byte. Basic Set support for pushbutton 4.

This parameter specifies how received **Basic Set** commands are handled.

<i>Value</i>	<i>Description</i>
0	Basic Set only controls the pushbutton indicator LEDs, ON/OFF. (Default)
1	Basic Set controls the internal switch status and the pushbutton indicator LEDs.
2	Basic Set is handled as if the user had activated the pushbutton, including transmission of commands via the association groups.

Parameter 44, Parameter size 1 byte. Pushbutton 4 LED indication.

This parameter specifies how the LED indication is controlled.

<i>Value</i>	<i>Description</i>
0	Internal LED control is disabled, only external commands control the indication.
1	The LED indication follows the switch status.
2	The LED indication follows the switch status – with inverted functionality.
3	Same as 1
4	Same as 2
5	The LED indication follows the status of the internal dimmer, ON or OFF.
6	The LED indication follows the status of the internal dimmer with inverted functionality, ON or OFF.
7	The LED indicator is ON for 5 seconds when the pushbutton is activated. (Default).

Parameter 45, Parameter size 1 byte. Colour commands for pushbutton 4 LED indication.

This parameter specifies how **Command Class Switch Color** commands are handled.

<i>Value</i>	<i>Description</i>
0	Direct control; the LED indication shows the received colour immediately, until the pushbutton is activated.
1	Colour command sets the colour for OFF indication. (Default).
2	Colour command sets the colour for ON indication.

Parameter 46, Parameter size 4 bytes. ON indication RGB-saturation for pushbutton 4.

This parameter specifies the saturation levels for the red, green and blue LEDs, when ON status is indicated. (Default is the ON-state indicated by a 50% blue colour).

<i>Value</i>	<i>Description</i>
Byte 1: Colour saturation, red.	
0 - 255	Specifies the saturation for the red LEDs. (Default is 0)
Byte 2: Colour saturation, green.	
0 - 255	Specifies the saturation for the green LEDs. (Default is 0)
Byte 3: Colour saturation, blue.	
0 - 255	Specifies the saturation for the blue LEDs. (Default is 127)
Byte 4: LED control.	
0 - 255	LED indicator control; see the application note about this parameter. (Default is 0)

Parameter 47, Parameter size 4 bytes. OFF indication RGB-saturation for pushbutton 4.

This parameter specifies the saturation levels for the red, green and blue LEDs, when OFF status is indicated. (Default is the OFF-state indicated as a low white light on 5%).

<i>Value</i>	<i>Description</i>
Byte 1: Colour saturation, red.	
0 - 255	Specifies the saturation for the red LEDs. (Default is 47).
Byte 2: Colour saturation, green.	
0 - 255	Specifies the saturation for the green LEDs. (Default is 47)
Byte 3: Colour saturation, blue.	
0 - 255	Specifies the saturation for the blue LEDs. (Default is 47)
Byte 4: LED control.	
0 - 255	LED indicator control; see the application note about this parameter. (Default is 0)

10 Technical specifications

Power supply	230V AC / 50 Hz
Load	0 – 200VA / 0 – 250W
Fuse	T2A (not replaceable by customer)
Connection terminals	Push-in terminals: 0,2 – 2,5 mm ² / 24 – 12 AWG
Connections	2 x Line (looped internally) 2 x Neutral (looped internally) 1 x Dimmer Line Output
Power consumption	Standby: 0,6 W.
Radio protocol	Z-Wave®: EU 868.4MHz – 500 Series.
Approvals	CE EN 50491-3: 2009 EN 60669-2: 2004 Z-Wave Plus
Explorer Frame Support	Yes
SDK	6.81.03
Device type	Slave med repeater functionality.
Generic Device Class	Wall Controller
Specific Device Class	Basic Wall Controller
Routing	Yes
FLiRS	No
Z-Wave Plus	Yes
Firmware Version	1.02
Security	Security S0, Security S2, SmartStart

